



## Dual High-Voltage Trench MOS Barrier Schottky Rectifier

Ultra Low  $V_F = 0.375\text{ V}$  at  $I_F = 5\text{ A}$

### Major Ratings and Characteristics

$I_{F(AV)}$	2 x 20 A
$V_{RRM}$	100 V
$I_{FSM}$	250 A
$V_F$ at $I_F = 20\text{ A}$	0.61 V
$T_J$ max.	150 °C

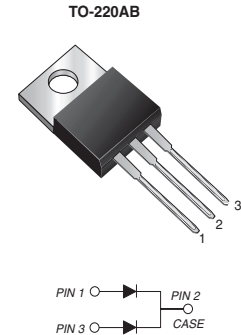

### Features

- Trench MOS Schottky Technology
- Low forward voltage drop, low power losses
- High efficiency operation
- Low thermal resistance
- Solder Dip 260 °C, 40 seconds



### Mechanical Data

**Case:** TO-220AB

Epoxy meets UL 94V-0 flammability rating

**Terminals:** Matte tin plated leads, solderable per J-STD-002B and JESD22-B102D

E3 suffix for commercial grade

**Mounting Torque:** 10 in-lbs Maximum

### Typical Applications

For use in high frequency inverters, switching power supplies, freewheeling diodes, Oring diode, dc-to-dc converters and reverse battery protection.

### Maximum Ratings

$T_A = 25\text{ °C}$  unless otherwise specified

Parameter	Symbol	VTS40100CT	Unit
Maximum repetitive peak reverse voltage	$V_{RRM}$	100	V
RMS reverse voltage	$V_{RMS}$	70	V
DC blocking voltage	$V_R$	100	V
Maximum average forward rectified current (see Fig. 1)	$I_{F(AV)}$	40 20	A
Peak forward surge current 8.3 ms single half sine-wave superimposed on rated load	$I_{FSM}$	250	A
Peak repetitive reverse current per leg at $t_p = 2\text{ }\mu\text{s}$ , 1 kHz	$I_{RRM}$	1.0	A
Voltage rate of change (rated $V_R$ )	dv/dt	10000	V
Operating junction and storage temperature range	$T_J, T_{STG}$	- 20 to + 150	°C

## Electrical Characteristics

$T_A = 25\text{ }^\circ\text{C}$  unless otherwise specified

Parameter	Test condition		Symbol	Typ.	Max.	Unit
Breakdown voltage	at $I_R = 1.0\text{ mA}$	$T_J = 25\text{ }^\circ\text{C}$	$V_{(BR)}$	100 (minimum)	-	V
Instantaneous forward voltage <sup>(1)</sup> per leg	at $I_F = 5\text{ A}$ $I_F = 10\text{ A}$ $I_F = 20\text{ A}$	$T_J = 25\text{ }^\circ\text{C}$	$V_F$	0.463	-	V
				0.535	-	
				0.664	0.73	
	at $I_F = 5\text{ A}$ $I_F = 10\text{ A}$ $I_F = 20\text{ A}$	$T_J = 125\text{ }^\circ\text{C}$		0.375	-	
0.445			-			
0.605			0.67			
Reverse current at rated $V_{RM}$ <sup>(1)</sup> per leg	at $V_R = 70\text{ V}$	$T_J = 25\text{ }^\circ\text{C}$	$I_R$	13.7	500	$\mu\text{A}$
		$T_J = 125\text{ }^\circ\text{C}$		8.4	15	mA
	at $V_R = 100\text{ V}$	$T_J = 25\text{ }^\circ\text{C}$		69.6	1000	$\mu\text{A}$
		$T_J = 125\text{ }^\circ\text{C}$		22.5	45	mA

Notes:

(1) Pulse test: 300  $\mu\text{s}$  pulse width, 1 % duty cycle

## Thermal Characteristics

$T_A = 25\text{ }^\circ\text{C}$  unless otherwise specified

Parameter	Symbol	VTS40100CT	Unit
Typical thermal resistance per leg	$R_{\theta JC}$	2.0	$^\circ\text{C/W}$

## Ratings and Characteristics Curves

( $T_A = 25\text{ }^\circ\text{C}$  unless otherwise noted)

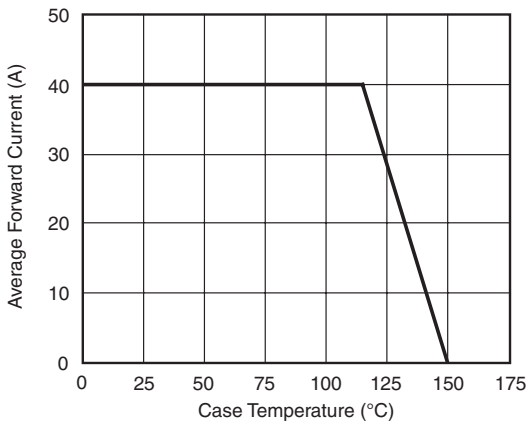

Figure 1. Forward Current Derating Curve

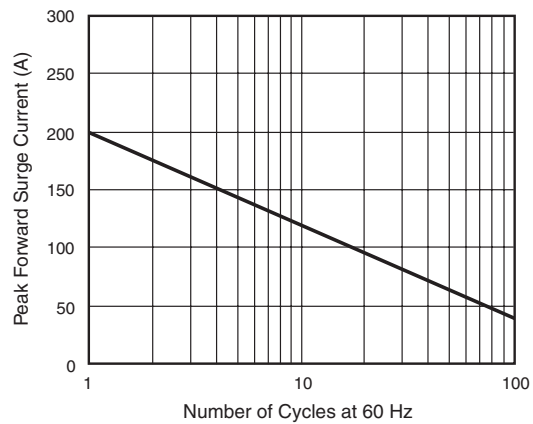

Figure 2. Maximum Non-Repetitive Peak Forward Surge Current

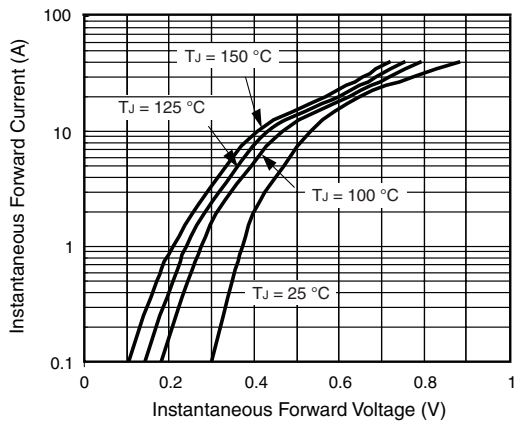

Figure 3. Typical Instantaneous Forward Characteristics Per Leg

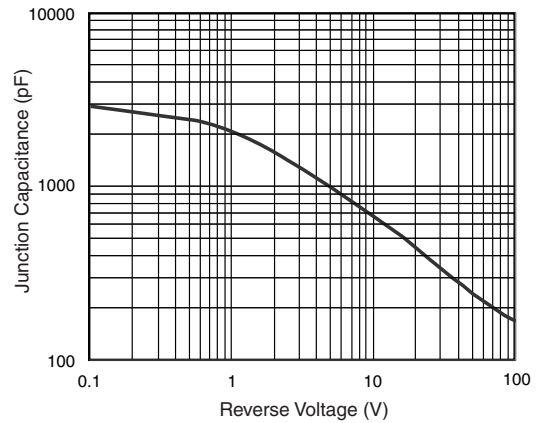

Figure 5. Typical Junction Capacitance

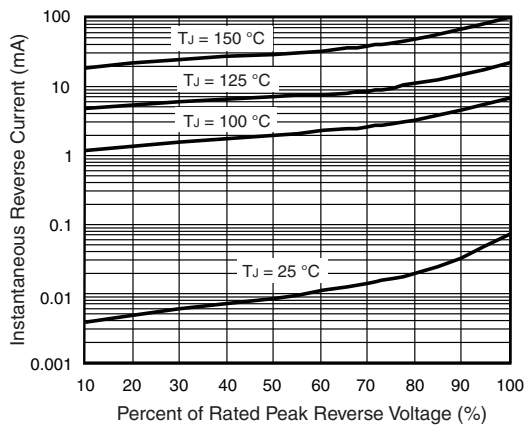

Figure 4. Typical Reverse Characteristics

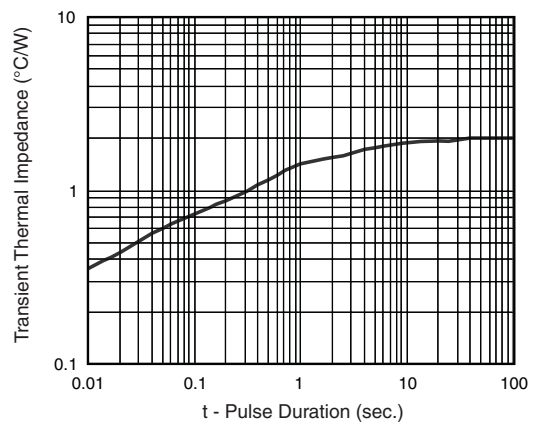
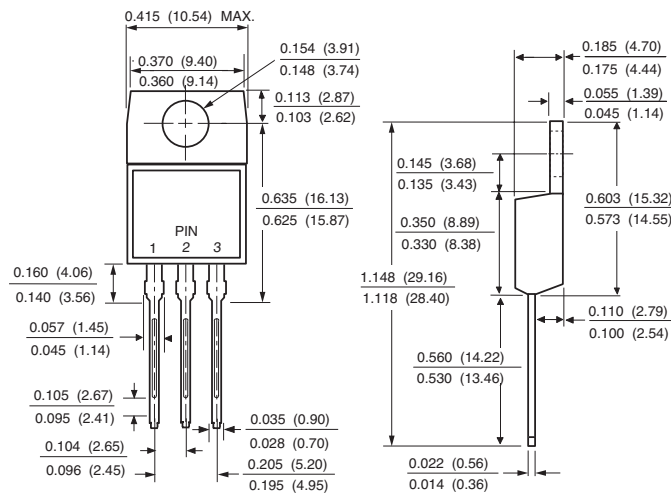

Figure 6. Typical Transient Thermal Impedance

## Package outline dimensions in inches (millimeters)

### TO-220AB





---

**Notice**

Specifications of the products displayed herein are subject to change without notice. Vishay Intertechnology, Inc., or anyone on its behalf, assumes no responsibility or liability for any errors or inaccuracies.

Information contained herein is intended to provide a product description only. No license, express or implied, by estoppel or otherwise, to any intellectual property rights is granted by this document. Except as provided in Vishay's terms and conditions of sale for such products, Vishay assumes no liability whatsoever, and disclaims any express or implied warranty, relating to sale and/or use of Vishay products including liability or warranties relating to fitness for a particular purpose, merchantability, or infringement of any patent, copyright, or other intellectual property right.

The products shown herein are not designed for use in medical, life-saving, or life-sustaining applications. Customers using or selling these products for use in such applications do so at their own risk and agree to fully indemnify Vishay for any damages resulting from such improper use or sale.